

the light

Events
Brochure

Banbury

Welcome to The Light Banbury

Whether you're planning a team away day, a client presentation, or a company celebration, we have everything you need to make it a success.

From boutique bowling and interactive darts to our arcade and a private karaoke room, we offer a unique mix of activities to bring your team together.

Our state-of-the-art cinema screens, ranging from 54 to 148 seats, are perfect for private screenings, presentations, and conferences, with cutting-edge technology to ensure a seamless experience.

We offer a range of packages guaranteed to deliver an unforgettable experience across a variety of private hire spaces, state-of-the-art screens and fun leisure activities that are perfect for your next event.

Get in touch today!

Tom Swan, Head of Sales
tom.swan@thelight.co.uk



10 minutes from Banbury Train Station
30 minutes from Oxford Train Station





Screen capacities

Screen 1

148 guests

Screen 2

54 guests

Screen 3 & 4

119 guests

Screen 5

89 guests

Screen 6

132 guests

Screen 7

54 guests



Hire fees

Full day (weekday)

09:00 - 17:00
from £775

2.5 hrs (weekday)

09:00 - 17:00
from £200

Evening and weekends

Available on
request

Host Your Own Private Cinema Experience

Bring your event to life with a fully immersive cinema experience tailored just for you.

Looking for a unique way to host your next event? Book a private screening at The Light, whether it's for a family movie night, a corporate presentation, or a fun team-building activity. With 7 state-of-the-art screens ranging from 54 to 148 seats, we provide a range of seating options including plush armchairs, recliners, and sofa beds. Enjoy a true cinema experience in a more intimate setting.

Choose from the latest blockbusters or classic films, all shown with top-tier technical facilities and support from our dedicated event team. We also offer customisable food and drink packages, featuring pizzas, burgers, cocktails, and more, to ensure your event is tailored to your needs. It's the perfect setting for making lasting memories with your group, all while enjoying the magic of the big screen





**Bowling
capacity**

Minimum
60 guests
Maximum
80 guests

Our *tenpin* bowling lanes are ideal for *team-building*, *parties*, and *celebrations*—guaranteeing a memorable time for all!

Strike Fun with Tenpin

Looking for a fun, engaging, and memorable way to host your next corporate event, private gathering, or birthday party? Look no further than our tenpin bowling lanes! Whether you're planning a team-building experience, a special celebration, or simply looking for an entertaining way to spend time with friends, we offer the perfect environment for all ages.

Gather your colleagues, friends or family and get ready to see who is going to be the winner at our classic tenpin bowling. We have ten lanes of boutique bowling, perfect for groups and parties.

Don't wait—book your lanes today! Secure the best dates for your event, and get ready for a memorable time at our tenpin bowling lanes!





Tenpin Bowling Floor Plan

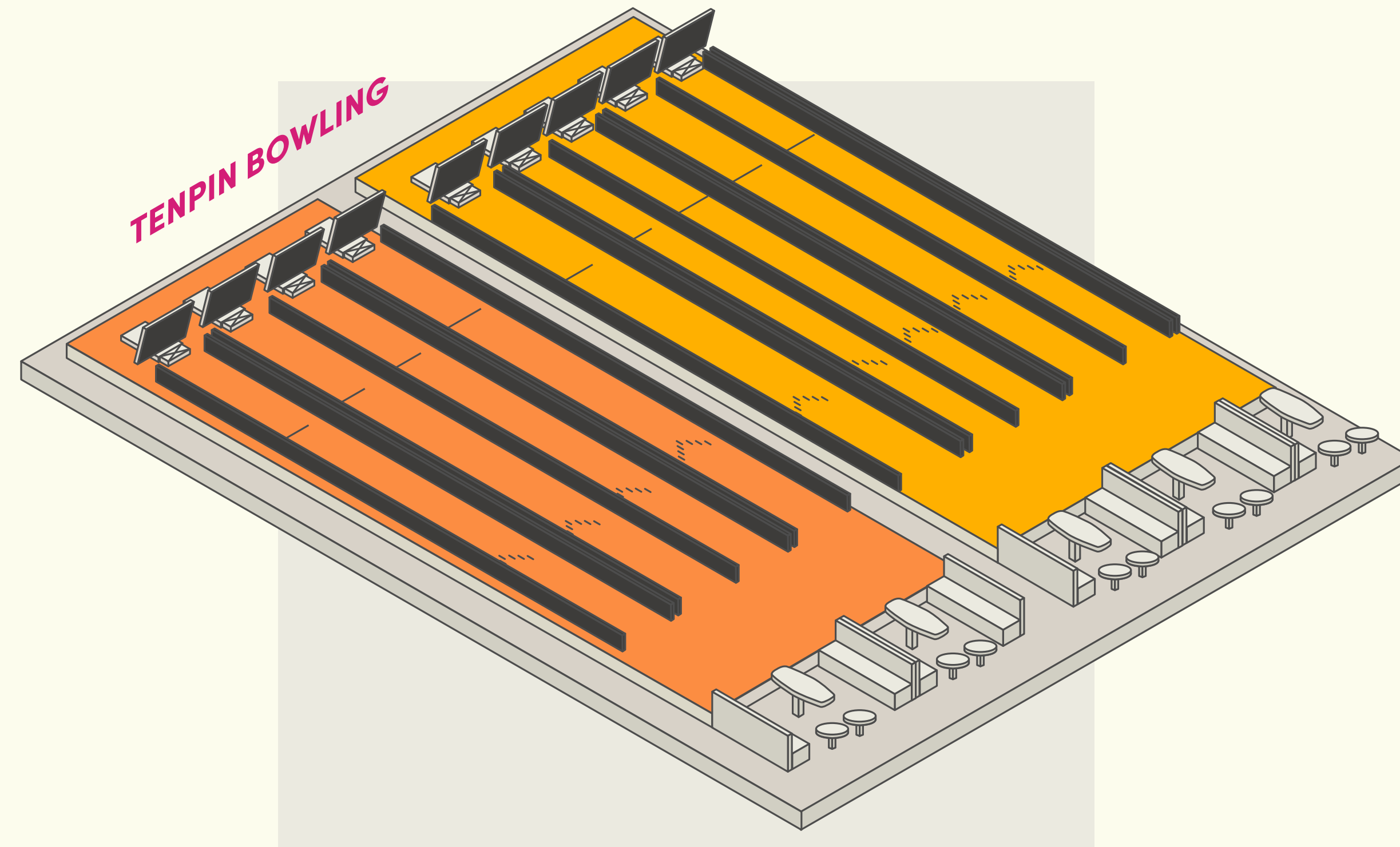

Hire fees

Weekday
17:00 - close
from £1,250

2 hrs
(weekday)
from £500

Weekends
Available on
request



We were very happy with the venue and it is the perfect location for us! It was our first time at The Light, but we will definitely be back."



Bowl, Game
& Lounge
capacity

Minimum

100 guests

Maximum

190 guests

Combine *tenpin bowling*, *American pool*, *air hockey*, and *karaoke* for the ultimate event—perfect for team-building, milestones, or a fun night out!

Bowl, Game & Lounge

Looking for a fun, engaging, and memorable way to host your next corporate event, private gathering, or birthday party? Look no further than our tenpin bowling lanes! Whether you're planning a team-building experience, a special celebration, or simply looking for an entertaining way to spend time with friends, we offer the perfect environment for all ages.

Gather your colleagues, friends or family and get ready to see who is going to be the winner at our classic tenpin bowling. We have ten lanes of boutique bowling, perfect for groups and parties.

Alongside, enjoy your very own amusement arcade! Get ready to get nostalgic with our Arcade Games! Win at fairground classics like Down the Clown and Allstars Basketball or challenge your group to new games like Mission Impossible and House of the Dead.

You'll also have access to your own private bar: The Lower Decks Bar! A versatile and stylish venue designed to cater to a wide range of events, from corporate networking functions to intimate birthday parties, social gatherings, and beyond. Located in the heart of Banbury, this unique space is perfect for those looking to host an event in a modern, vibrant setting that combines comfort, style, and convenience.



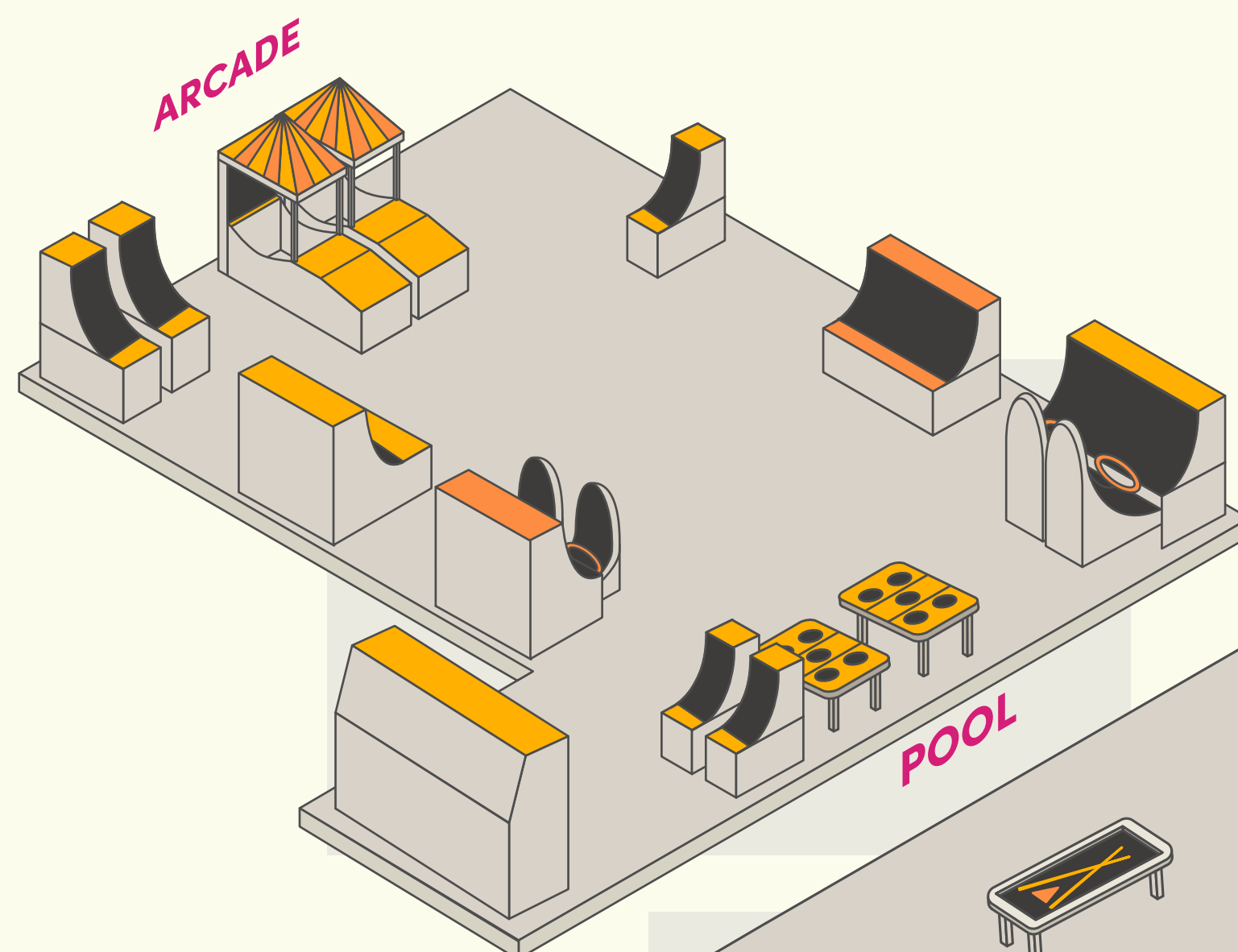

Bowl, Game & Lounge Floor Plan

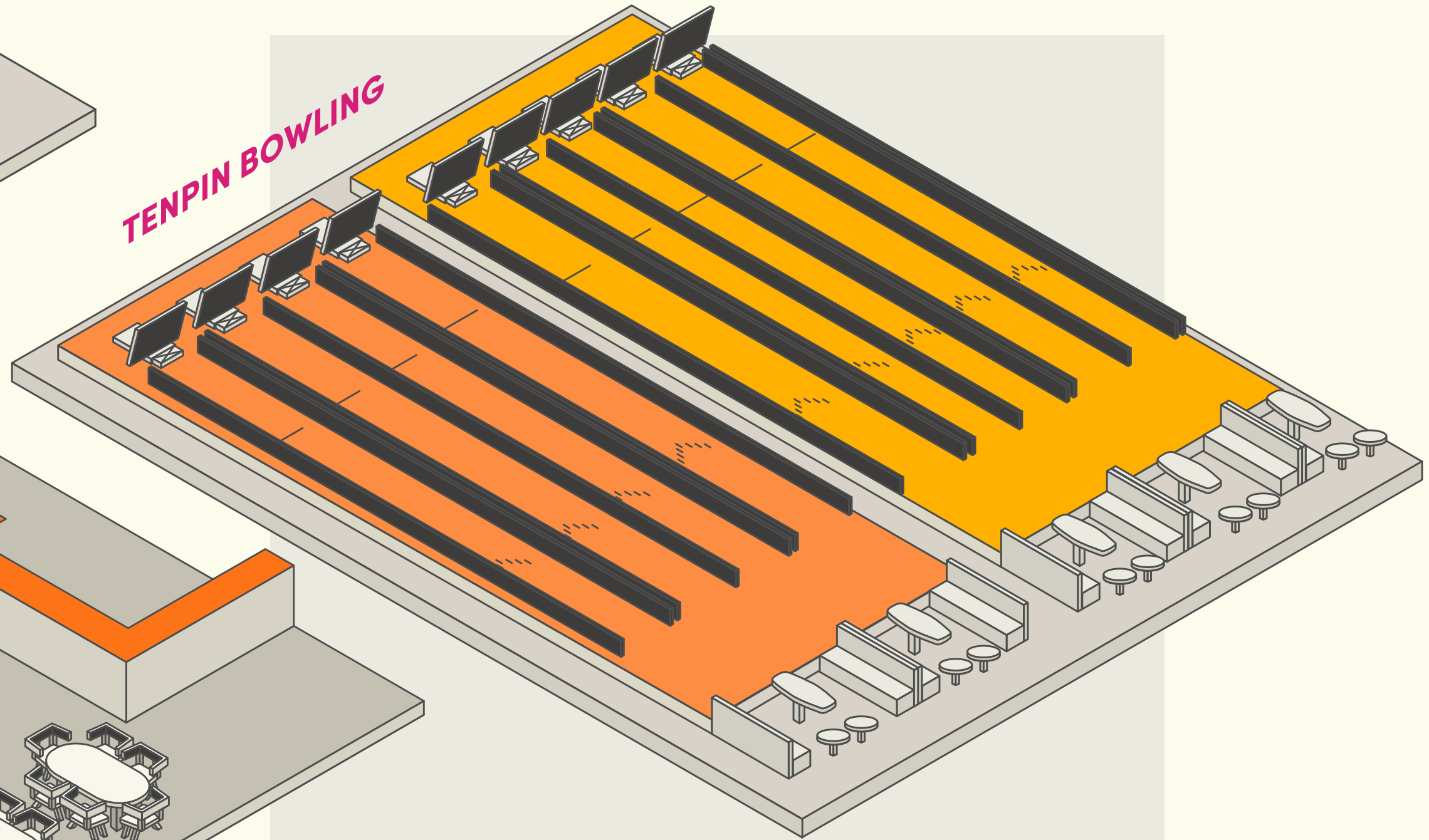
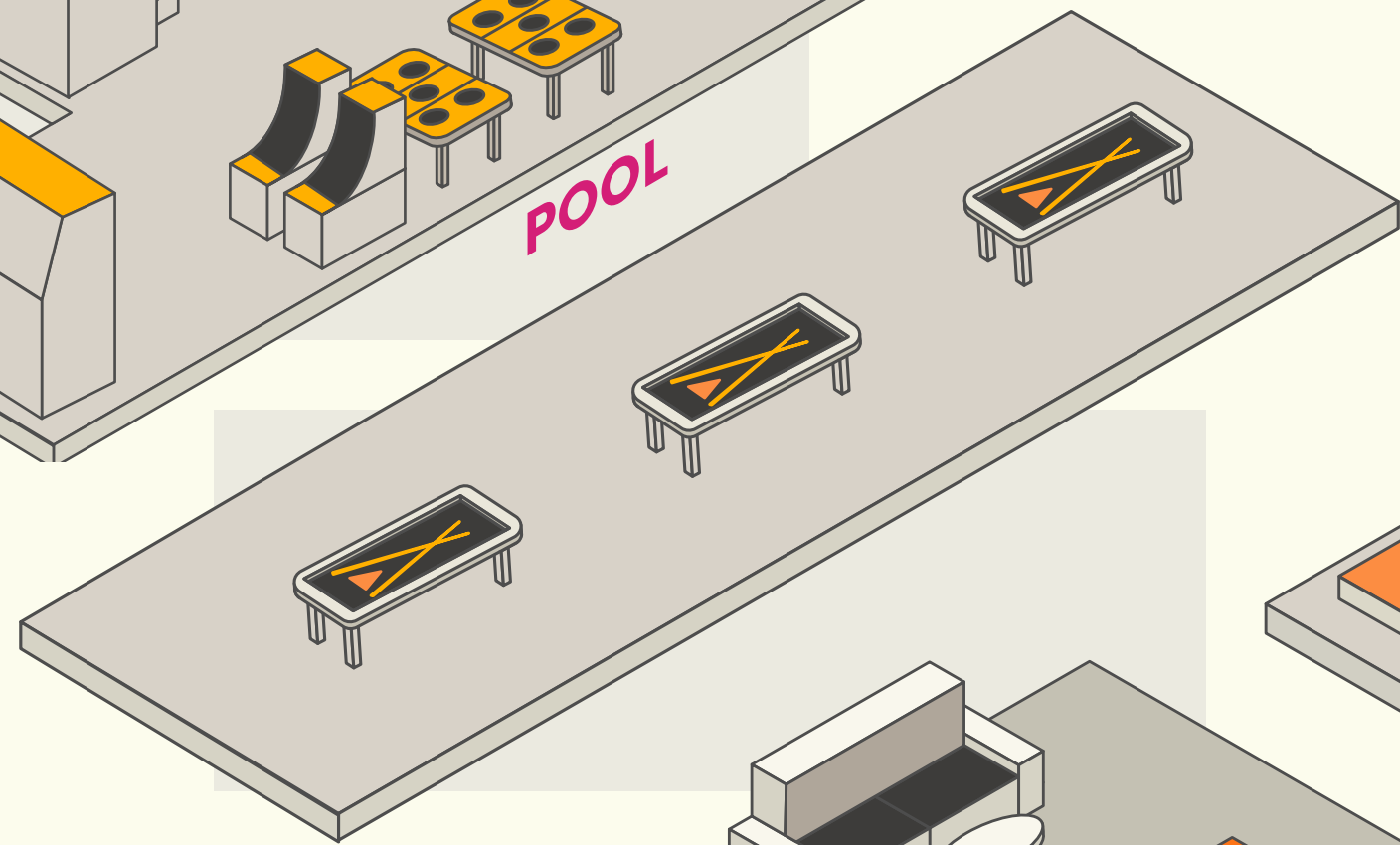

Hire fees

Weekday
17:00 - close
from £4,500

2 hrs
(weekday)
from £1,800

Weekends
Available on request



Fantastic - everything went really well. Our first time visiting and have already spoken to our boss about making a return."

Throw, Bowl
& Sing
capacity

Minimum
50 guests
Maximum
80 guests

Our Mezzanine level offers fun, competition, and relaxation—ideal for private parties, corporate events, and more!

Putt, Throw & Sing

Immerse yourself in our film-themed mini-golf with holes inspired by iconic movies like *Jaws* and *Star Wars*. Compete with friends while reliving classic scenes.

Add two interactive darts oches with a variety of games – challenge friends or colleagues for bragging rights.

Wrap up your evening in your very own private karaoke room featuring thousands of songs from every decade. Enjoy drink packages, platters, and a private bar on the Mezzanine.



Putt, Throw & Sing Floor Plan

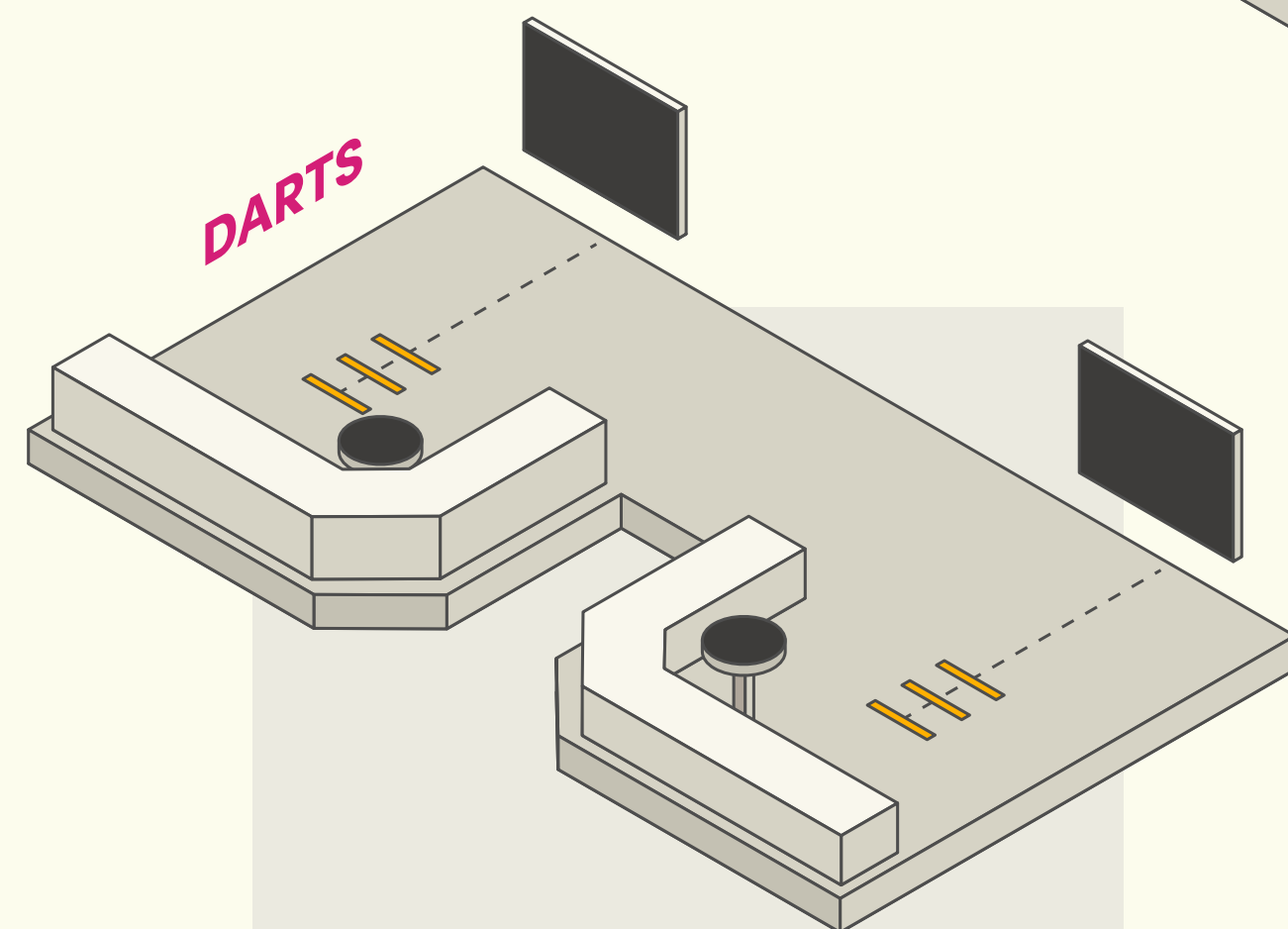
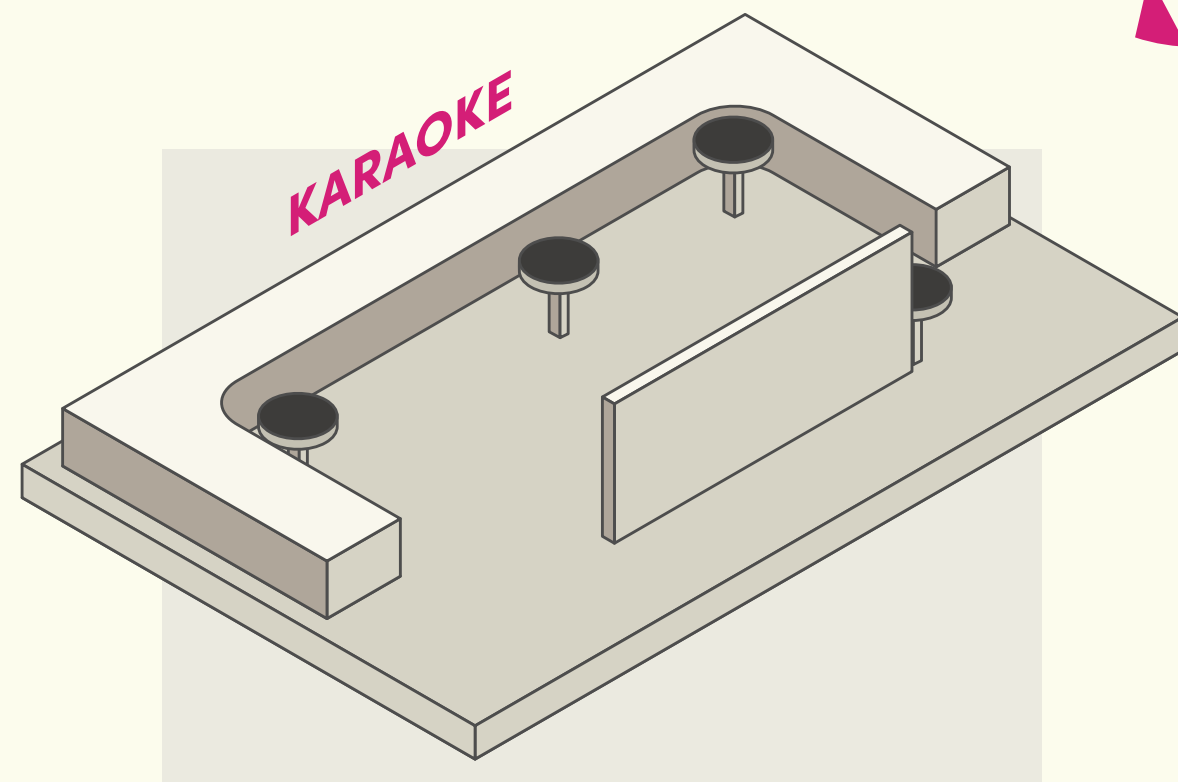

Hire fees

Weekday

17:00 - close
from £3,250

2 hrs (weekday)

from £1,300

Weekends

Available on
request



Loved the interactive darts for a bit of healthy competition to follow our meeting! Thanks again for making it a seamless afternoon with our clients."



Mini Golf capacity

Minimum

20 guests

Maximum

40 guests

Add a twist of fun to your next group outing with our film-themed *mini golf*. Ideal for corporate events, private parties or just a great time, it's a playful, memorable experience everyone will enjoy!

Mini Golf

Get ready for a unique and immersive mini-golf experience like no other at The Light's Film-Themed Mini Golf Course. With each hole inspired by iconic moments from your favourite movies, this course is perfect for anyone who loves a bit of fun, friendly competition, and a touch of Hollywood glamour. Whether you're a film buff or just looking for a fun way to spend time with friends, family, or colleagues, our mini-golf course offers an exciting, cinematic adventure that's sure to leave you with lasting memories.

Spice up your next team-building event or work outing with a round of mini-golf that's anything but ordinary. Bond with colleagues over your favourite films and friendly competition while navigating the exhilarating course.

Also perfect for friends and families who want to enjoy a laid-back yet entertaining activity. Take a break from the usual and enjoy an exciting round of mini-golf together in a film-inspired world.

Book your round of film-themed mini-golf today! Step into the world of cinema, challenge your friends, and enjoy an immersive, entertaining experience at The Light's Film-Themed Mini Golf Course. Whether you're planning a corporate event, birthday party, or group outing, this course guarantees fun for all ages!





Mini Golf Floorplan



Hire fees

Weekday

17:00 - close
from £1,250

2 hrs (weekday)

from £500

Weekends

Available on
request



I can't imagine
booking our
company
Christmas
party anywhere
else! You are
all amazing -
thank you!"

 Adventure
Climb
capacity

Minimum
25 guests
Maximum
25 guests

Reach new heights with our *climbing walls*. Perfect for adding adventure, challenge, and a bit of friendly rivalry to any event. It's an energising activity that's fun for all abilities!

Reach New Heights with Adventure Climb

Get ready for an adrenaline-pumping adventure at our climbing wall, featuring 26 different climbs across 3 distinct zones. Whether you're a seasoned climber or a beginner, our climbing wall offers challenges for all skill levels. From tackling high-intensity routes in the Challenge Zone, testing your strength and agility in the Bouldering Zone, to mastering obstacles in the exciting Ninja Zone, there's something for everyone. Perfect for corporate events, birthday parties, or group outings, our climbing wall guarantees a fun and exciting experience!

Step up your climbing game in our Challenge Zone, designed for those who want to push their limits and take on more technical routes. With a variety of walls and difficulty levels, this zone is perfect for climbers looking to test their endurance and skill. Whether you're scaling steep faces or navigating challenging overhangs, the Challenge Zone offers a heart-racing experience for climbers of all abilities.

For climbers who prefer short, intense bursts of activity, the Bouldering Zone is the place to be! This zone focuses on low-level climbing that emphasizes technique, balance, and strength. The bouldering walls vary in difficulty, with problems designed to challenge your mind and body. Whether you're a beginner or an experienced climber, the Bouldering Zone is a great way to improve your skills while having fun.

Ready to take on a whole new level of excitement? Our Ninja Zone offers an obstacle course-style experience that blends climbing with agility challenges. Test your strength, speed, and flexibility as you tackle various obstacles designed to challenge even the most skilled climbers. Perfect for those looking for a dynamic and fun challenge!





Adventure Climb Floorplan

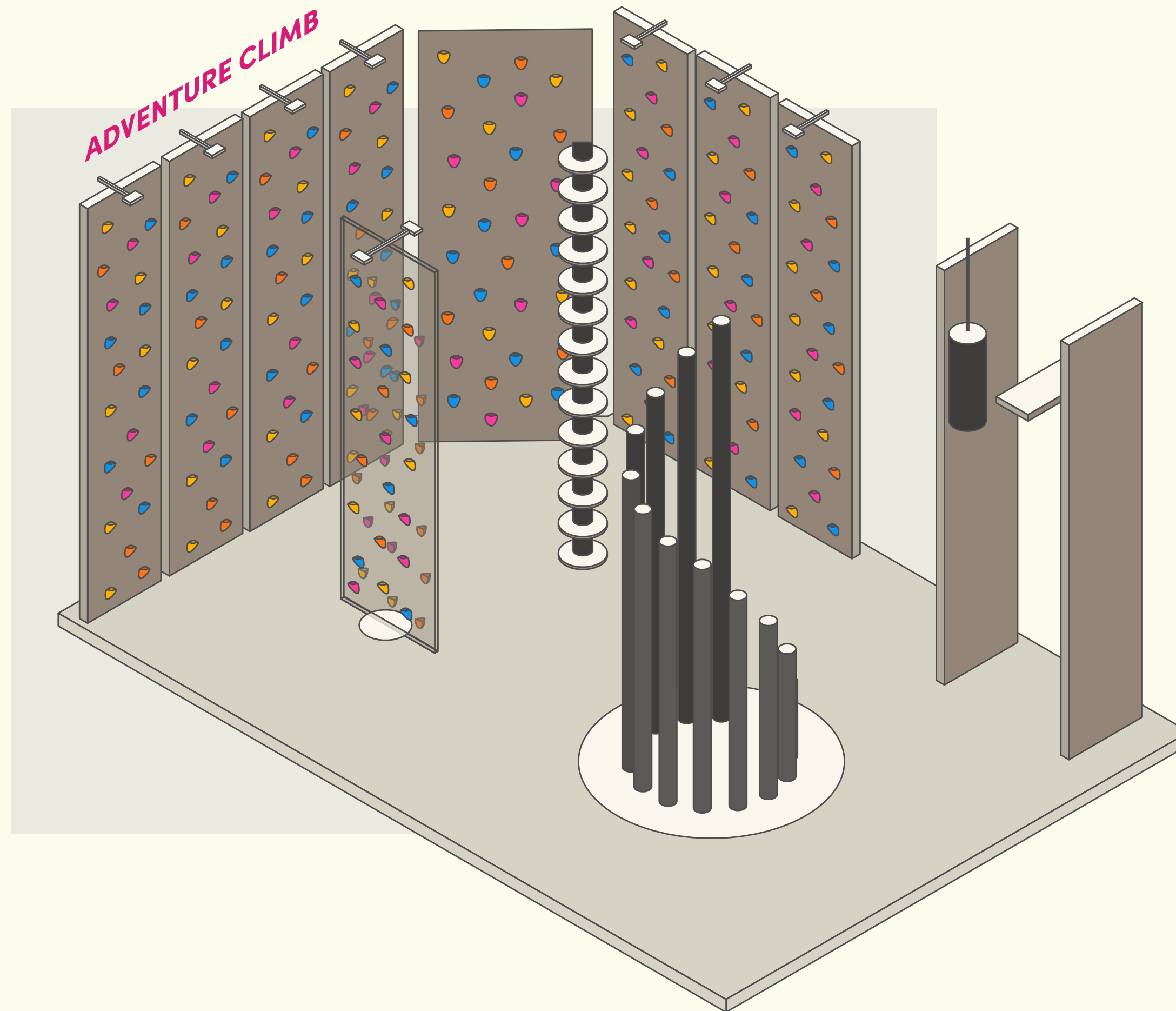

Hire
fees

Weekday

(hourly)
from £250

Weekends

(hourly)
from £375



Lower Decks Bar capacity

Minimum

20 guests

Maximum

50 guests

Host your next event in style at *The Lower Decks Bar*, perfect for everything from networking nights to birthday celebrations. With its own bar, terrace, and entrance, it's a relaxed yet refined spot for memorable get-togethers of all kinds.

Lower Decks Bar

The Lower Decks Bar at The Light Banbury is a versatile and stylish space designed to cater to a wide range of events, from corporate networking functions to intimate birthday parties, social gatherings, and beyond. This unique space is perfect for those looking to host an event in a modern, vibrant setting that combines comfort, style, and convenience.

Upon entering The Lower Decks, guests are greeted by a contemporary, yet warm ambiance that encourages relaxation and social interaction. The space is thoughtfully designed to be flexible, offering a dynamic atmosphere that can easily adapt to the specific needs of any event. Whether you're hosting a networking event or birthday celebration, The Lower Decks Bar has the versatility to match the tone of your occasion.

One of the standout features of The Lower Decks Bar is its private bar. This dedicated space allows guests to enjoy a wide selection of drinks, from craft beers and cocktails to fine wines and spirits, with a range of drinks packages on offer.

The venue is equipped with a private entrance, offering easy access and complete privacy for your guests. This ensures a seamless experience from the moment they arrive, avoiding any interruptions from other visitors or patrons. Whether you're hosting a large gathering or a smaller, more intimate get-together, The Lower Decks Bar guarantees an exclusive atmosphere where your event remains the focus.

For those who prefer to enjoy the outdoors, The Lower Decks Bar offers direct access to a beautiful terrace. This additional space is perfect for guests who want to step outside and enjoy the fresh air, offering a relaxed setting for conversation.

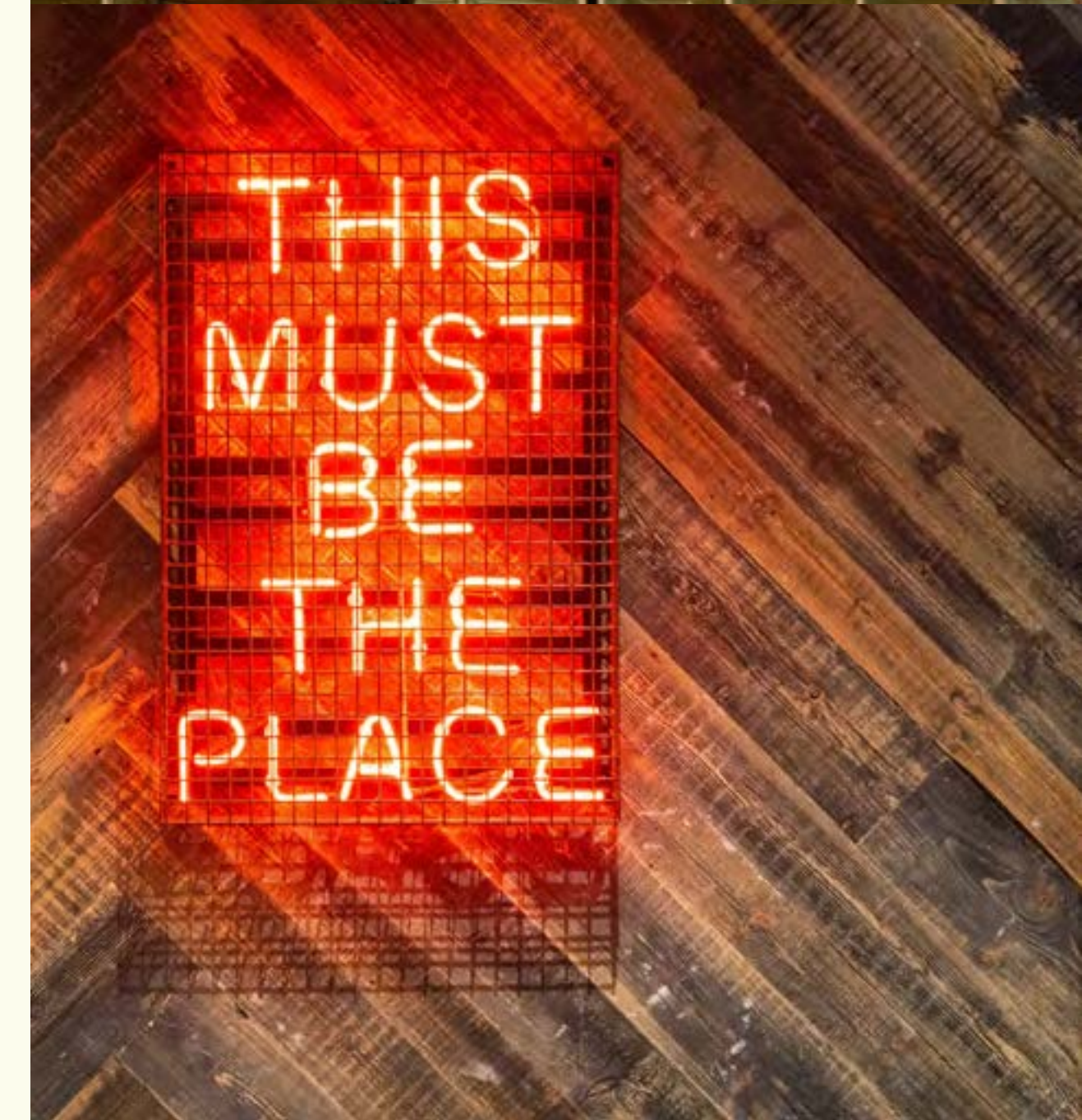



Lower Decks Bar Floorplan

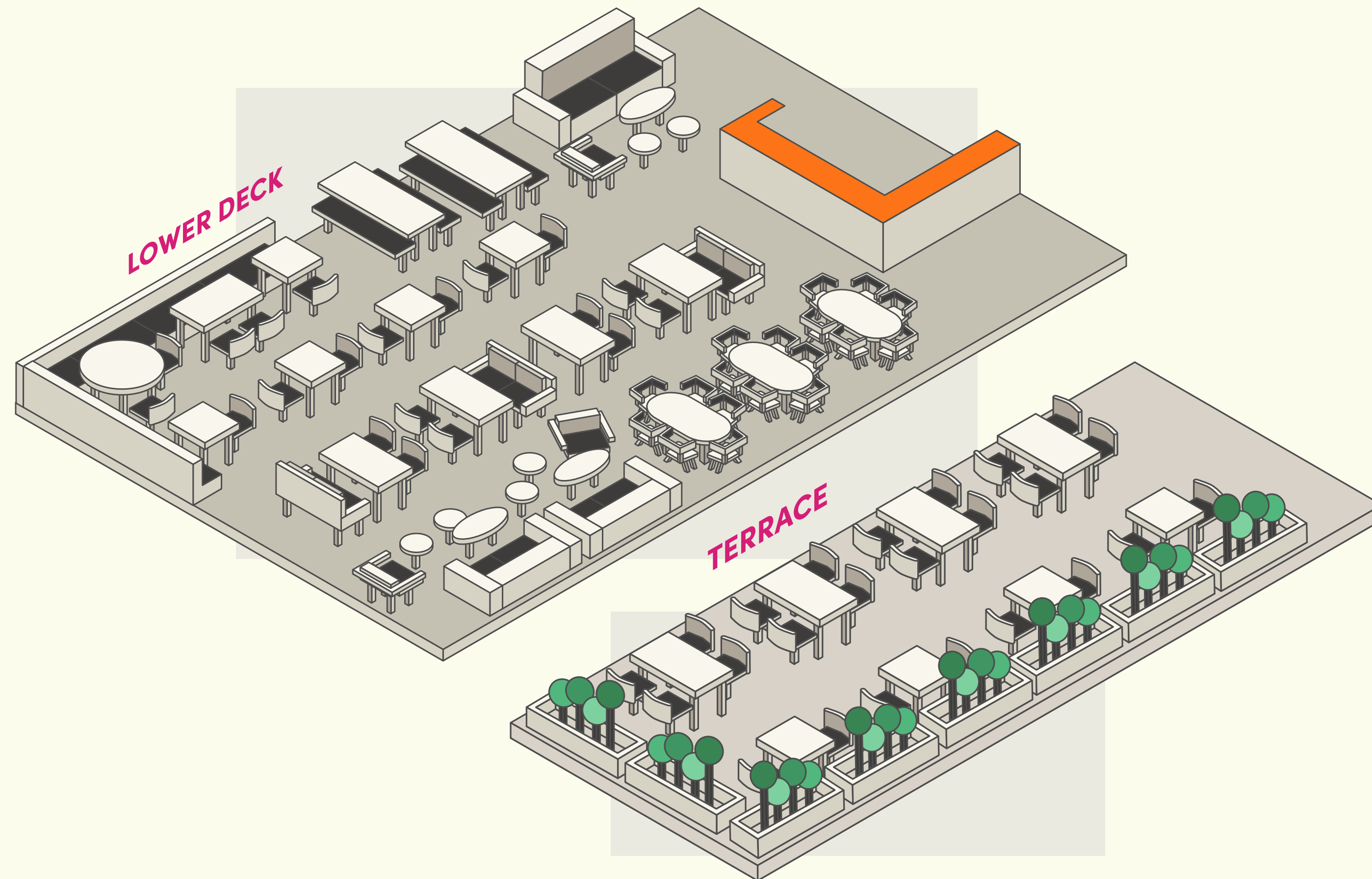

Hire
fees

Weekday

17:00 - close
from £500

2 hrs (weekday)

from £200

Weekends

Available on
request



All the team
were amazingly
welcoming &
the catering
was fantastic!"

 Green Room
capacity

Standing
25 guests

Boardroom
20 guests

Looking for a smart, flexible space for your next meeting or celebration? *The Green Room* is ideal for groups who want a private space with a polished touch.

The Green Room

The Green Room offers an exceptional venue for private events, corporate meetings, and social gatherings. Whether you're hosting a corporate event, a birthday party, or a group booking, The Green Room provides a flexible and stylish space that can be tailored to suit your needs.

With a standing capacity of up to 30 guests, the room is perfect for networking events or casual social events. For more structured gatherings, The Green Room offers boardroom-style seating for 20 guests, great for presentations or private dinners, and comes with a large flatscreen TV. Alternatively, for more intimate, focused meetings, the room can be set up to ensure a comfortable and professional environment for discussions and decision-making.

The contemporary design and versatile layout options make The Green Room a prime choice for your next event. Guests will appreciate the combination of modern amenities and the inviting atmosphere, all within the vibrant and central location of The Light, Banbury.

We have a range of day delegate packages to cater for your event, with refreshments, a mouthwatering breakfast offering, buffet-lunch, as well as cinema classics too!

Whether you're planning a business seminar, a corporate team-building event, or a celebration with friends and family, The Green Room provides a unique and adaptable space to meet your requirements.





The Green Room floorplan

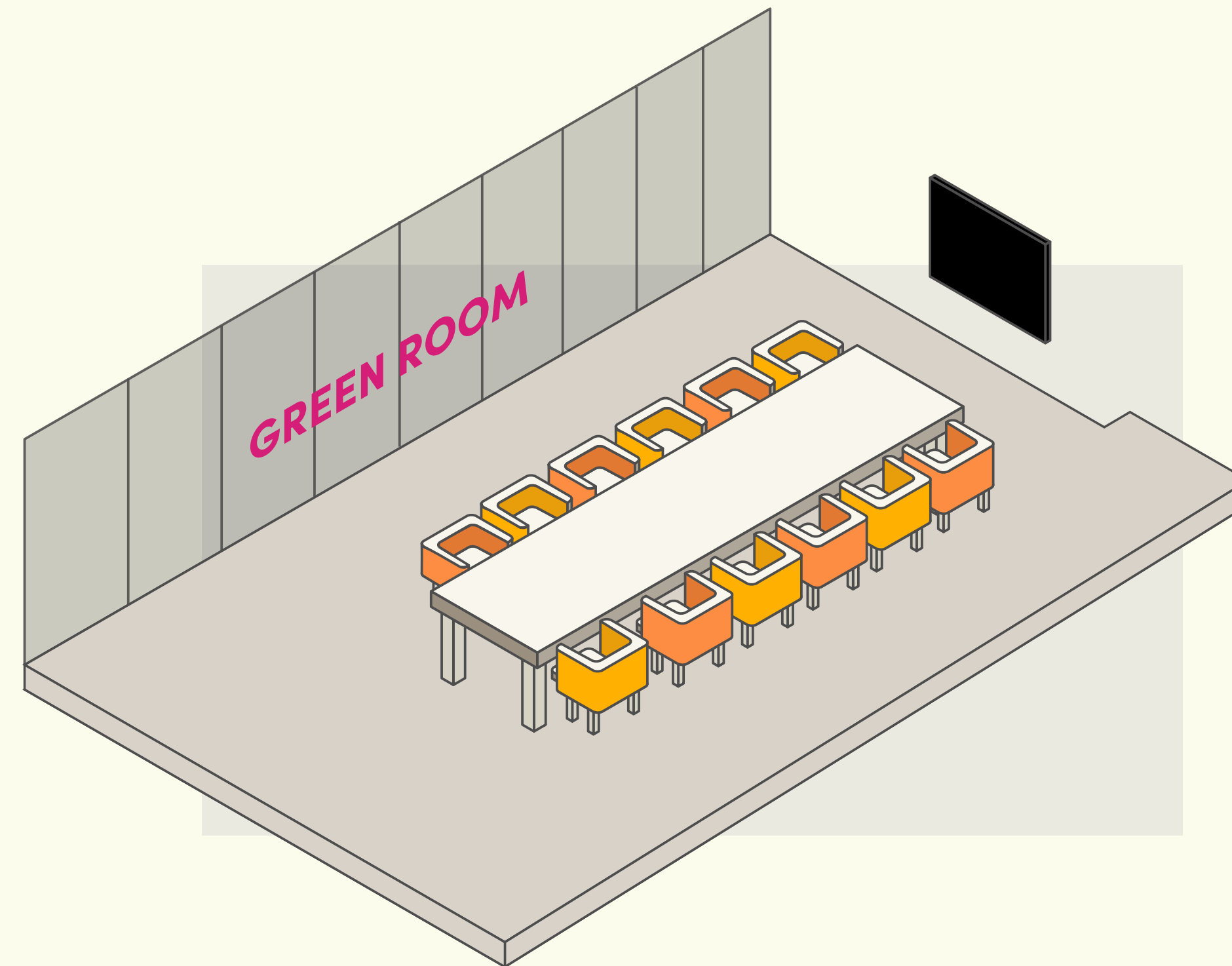

Hire fees

Weekday

17:00 - close
from £100

Weekends

Available on
request



The Greenhouse capacity

Dining

100 guests

Standing

170 guests

A stylish and versatile event space, The Greenhouse offers the perfect setting for meetings, receptions, and private gatherings, complete with tailored catering and a welcoming atmosphere.

The Greenhouse

The Greenhouse provides a unique space which can cater for a variety of events from corporate gatherings, team celebrations and meetings. Our team are well versed in managing everything for you so you can relax knowing we can deliver a first class event. We have group menus already set up and ready to go, but can also create bespoke menus for you and your guests.

We have a range of spaces to suit all occasions and to facilitate a variety of set-ups for your requirements. We can provide an exclusive area in our restaurant or on the terrace for larger groups and our Green Room caters for 20 guests and can be used to host meetings, business lunches or used as a breakout space. The room comes with a 4k OLED screen and offers video conferencing facilities.

Our stunning Mediterranean style rooftop terrace and restaurant overlooking Banbury's historic canal offers a beautiful and unique wedding venue. On sunnier days, the retractable roof can open up and let the outside in.

Our dedicated team are on hand to ensure that the planning process is enjoyable and stress free from start to finish and our culinary team can help you create a bespoke menu that meets all your requirements and will delight you and your guests.



The Greenhouse floorplan

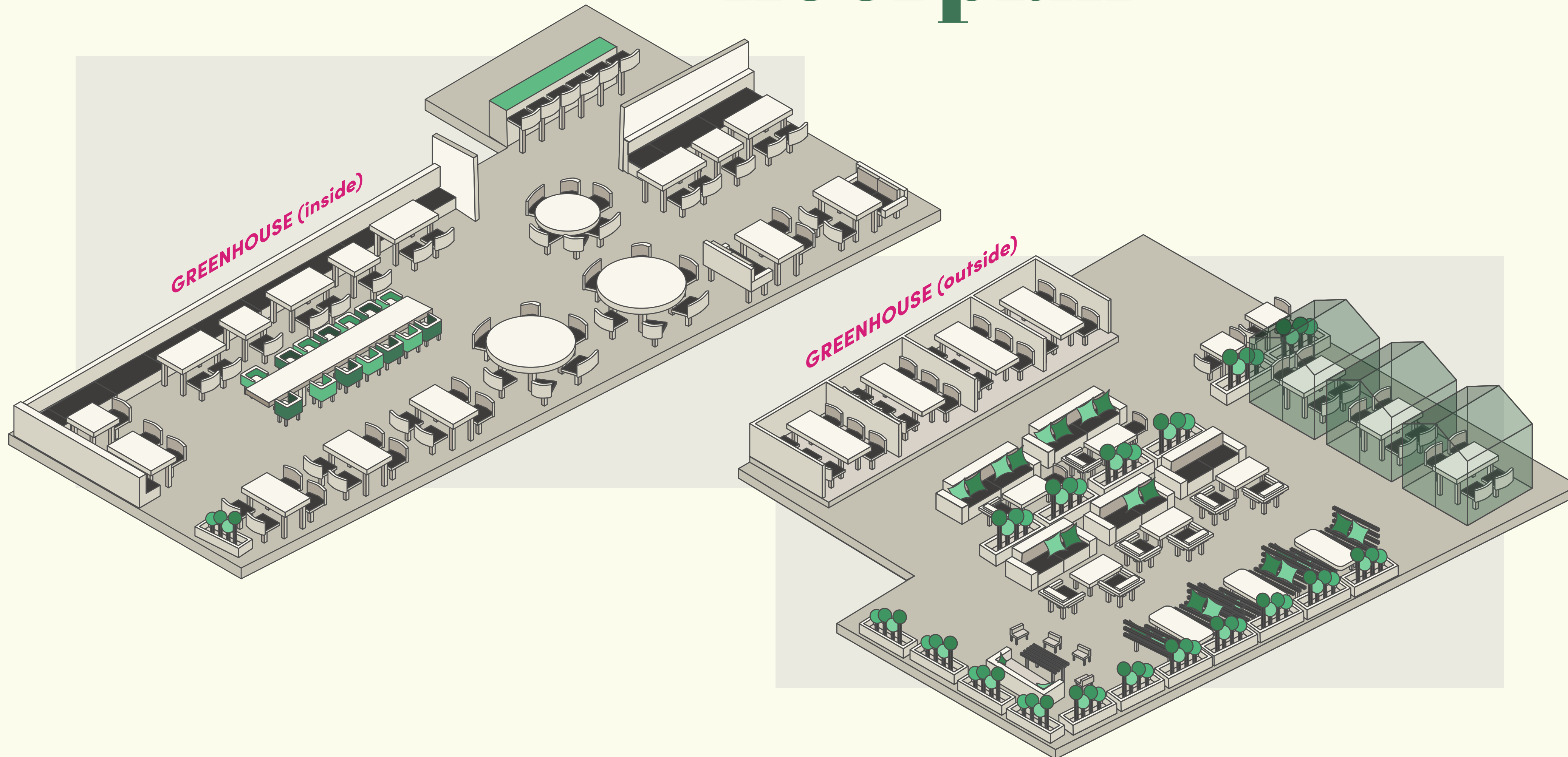

Hire fees

Min spend
£5,000 + £700
hire fee

Pick N Mix

Why not create an experience unique to you & your guests? Pick N Mix any number of our activities to customize your perfect event.

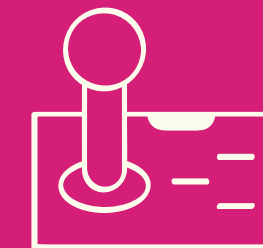

Add your very own Private Screen or our Green Room for a conference before or meeting space during your bespoke event!



Banbury

The Light,
Castle Quay Shopping Centre
Spiceball Park Road,
Banbury, OX16 2PA

Tom Swan, Head of Sales
tom.swan@thelight.co.uk